

RAIL CIRCLE TRACK Ø300cm

Installation Manual

1



Attention

Switch off the main power.

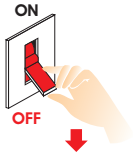

Track holders
 Ø300mm
 12pcs Track Holder

Connect the RAIL curved edges
 in order to make the RAIL Circle Track

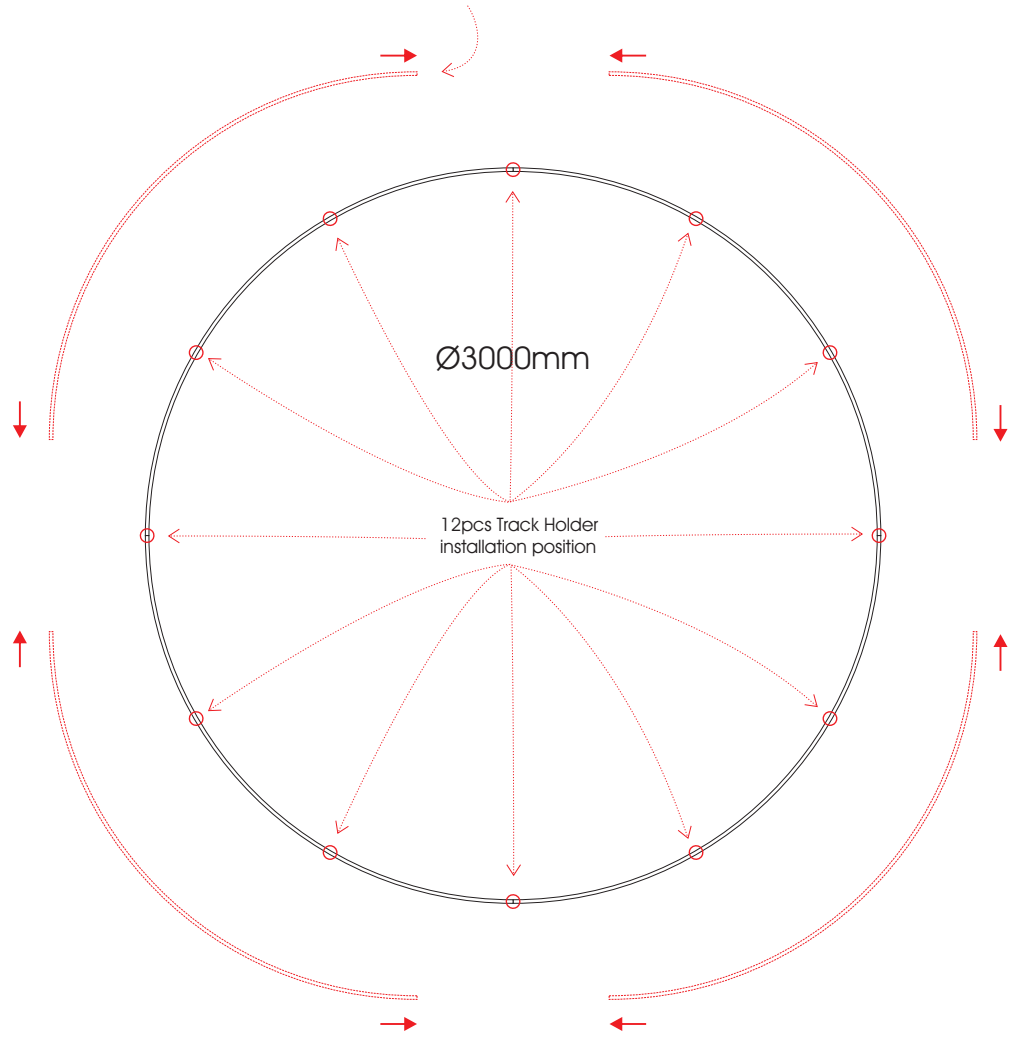

2

Screw Pole Bracket or
 Ceiling Suspension Installation
 to the ceiling

Plasterboard

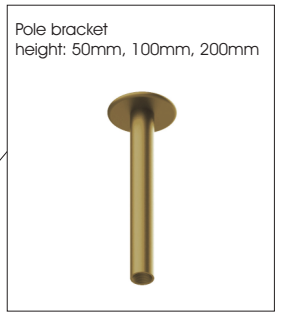

or



Pole bracket or
 Ceiling Suspension Installation

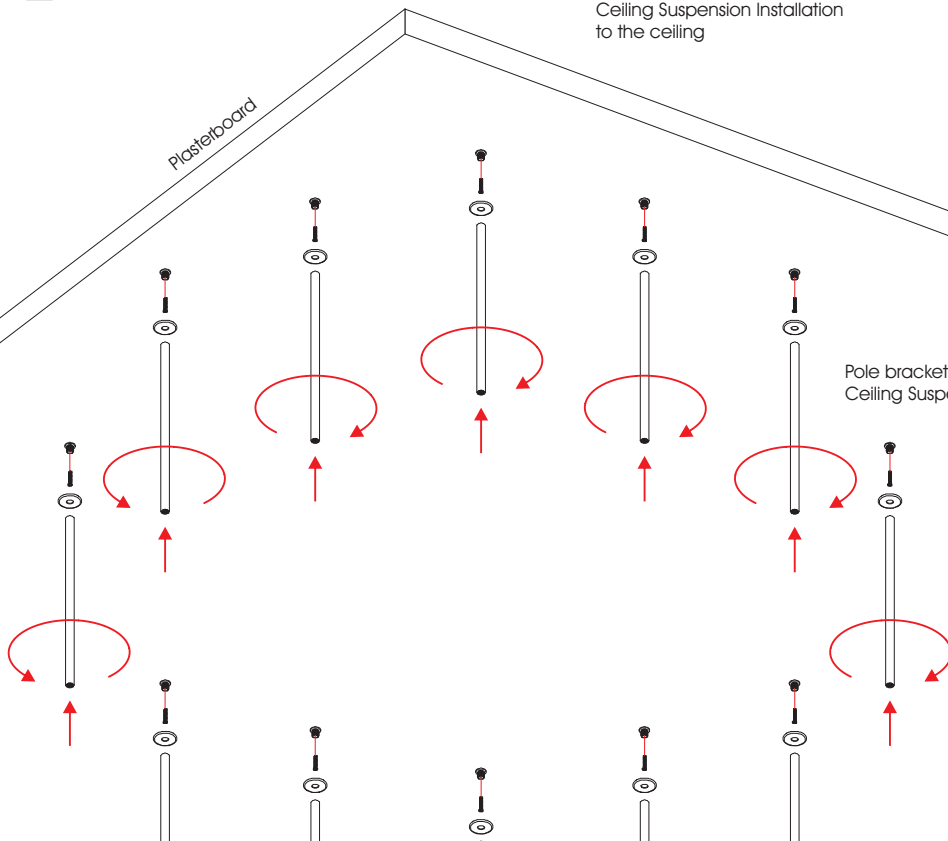

3

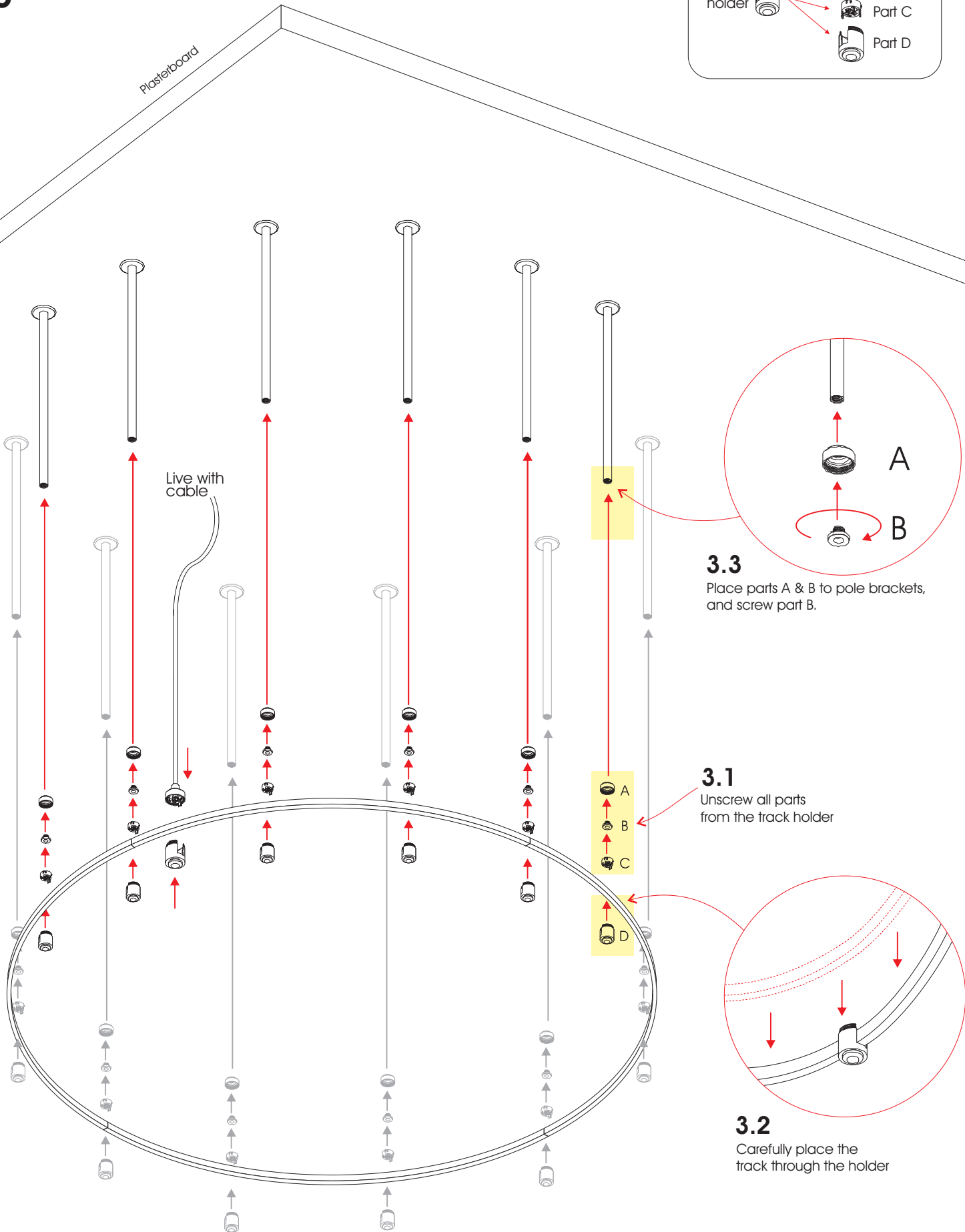
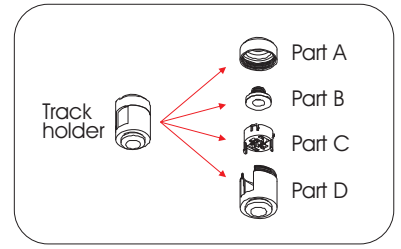

4

4.2

Make the connection

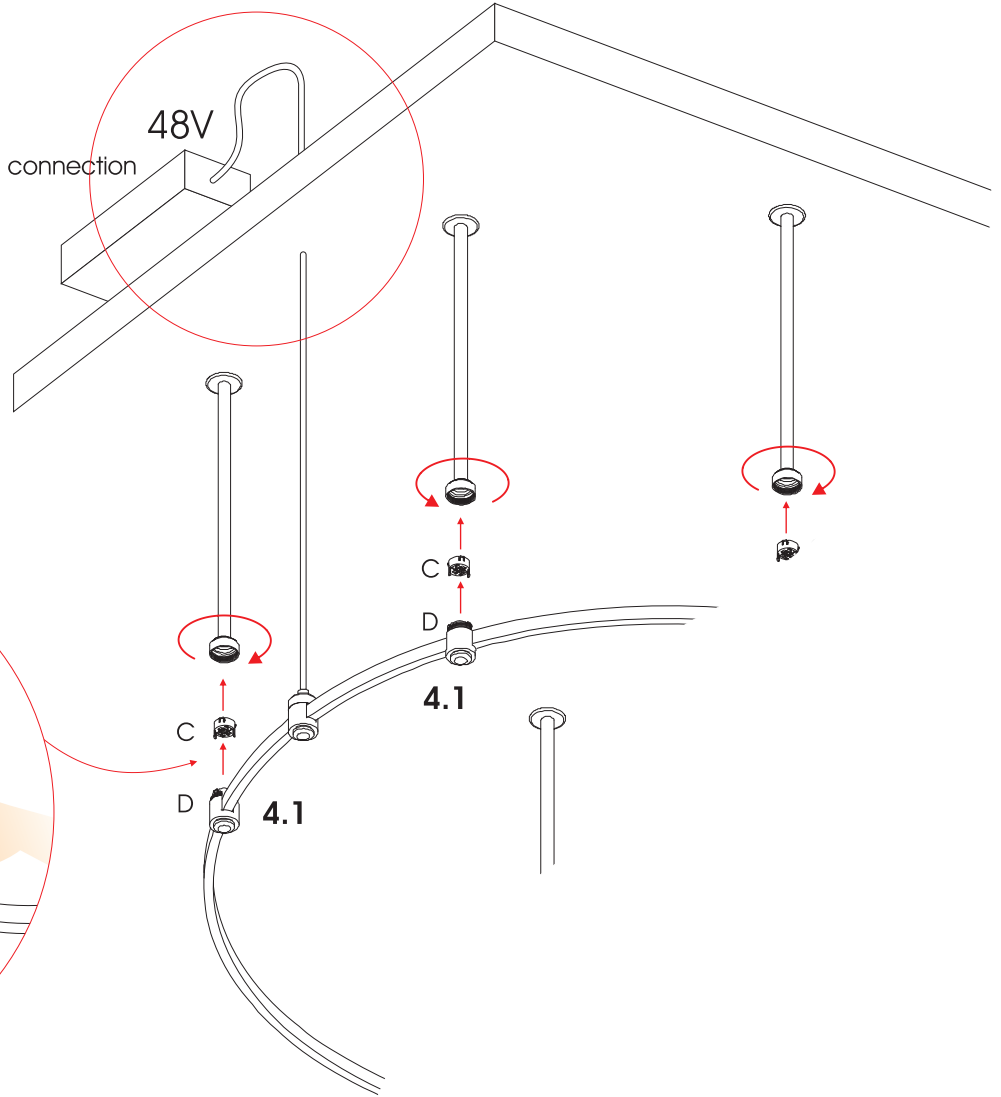

4.1

Place part C & D back on and tighten it carefully by rotating clockwise only upper parts

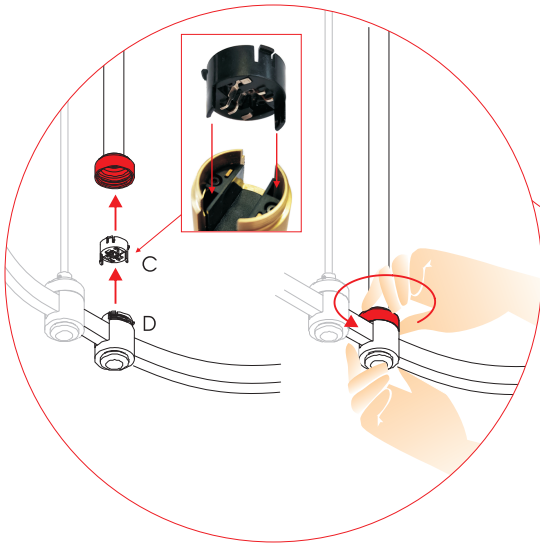

Installation of 2 tracks in a holder

1

A: Base part
B: Plate part

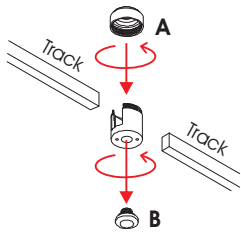

Unscrew Parts A and B from the track holder.

2

Carefully place the tracks through the holder.

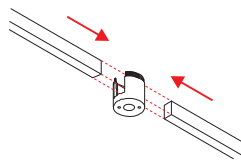

3

Attention!

Ensure that the two tracks are evenly aligned in the holder. Then, screw Part A back on and tighten it carefully.

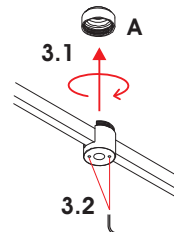

Secure the tracks by tightly screwing the Allen screws.

4

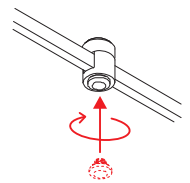

Finally place back on part B.

5

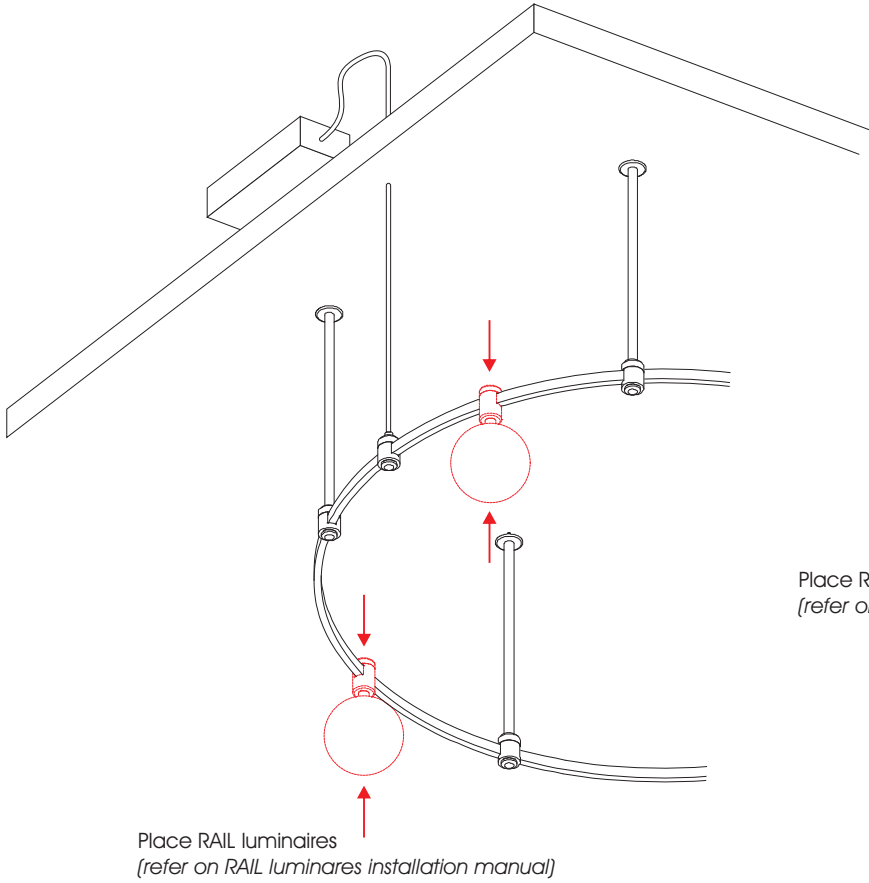

Place RAIL luminaires
(refer on RAIL luminaires installation manual)

6

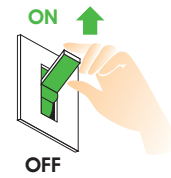
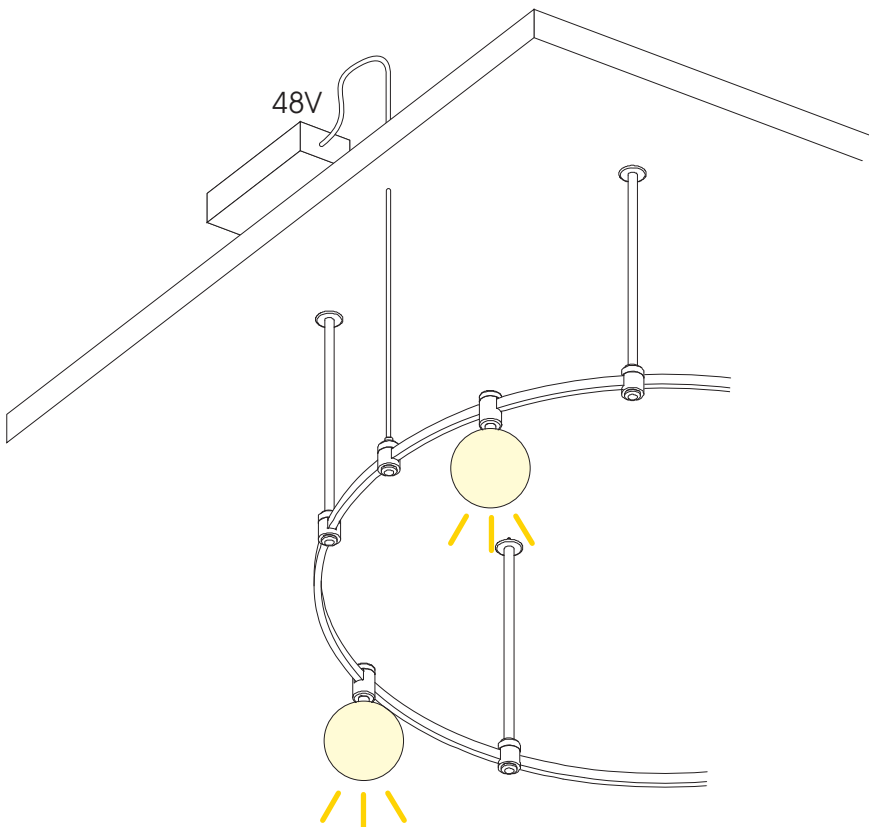

Installation with RAIL DRIVER BOX

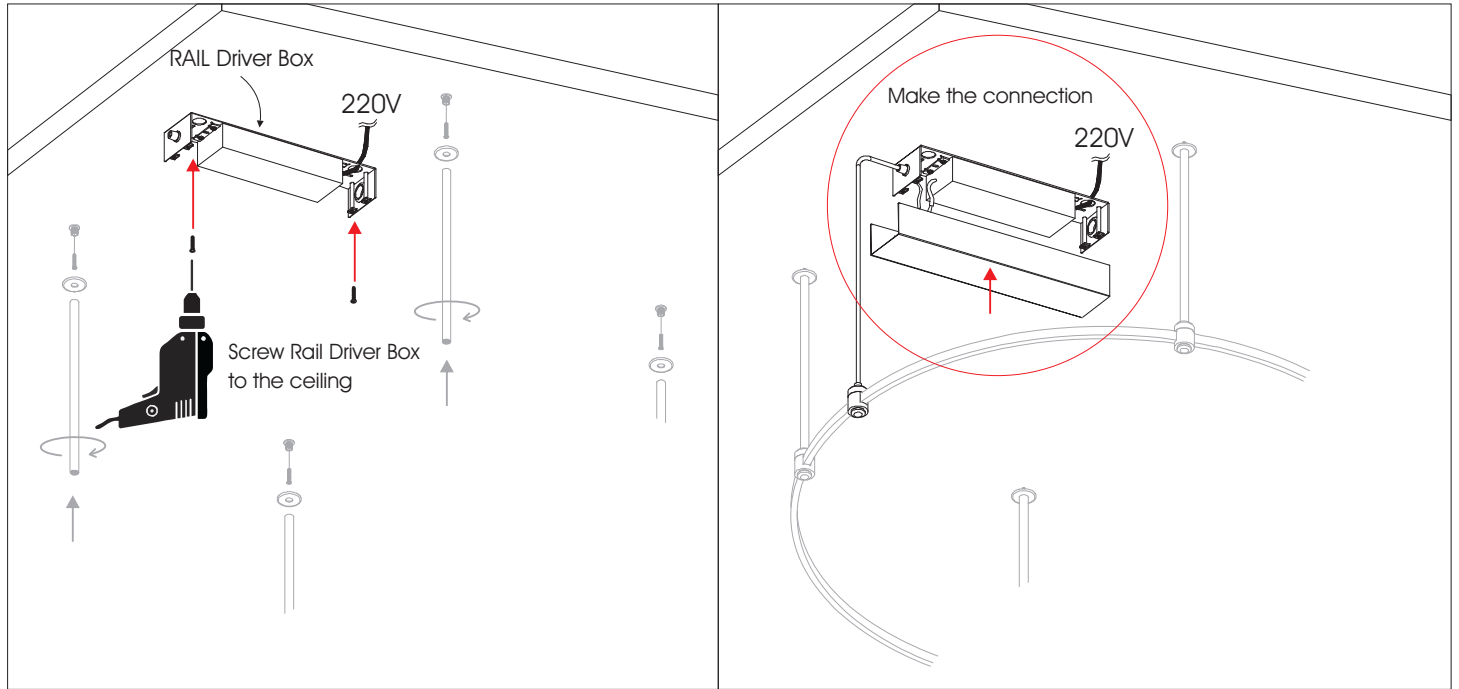

How to place RAIL luminaires in other position

